

CITY OF HOBART CIVIC BANNER

GUIDELINES



City of HOBART

TABLE OF CONTENTS

Introduction.....	3
Program Eligibility.....	3
Location of Civic Banner Programs.....	4
Program 1 – Arterial Banners	5
Program 2 – CBD Banners	6
Zones.....	7
Program 3 – North Hobart Banners	8
Program 4 – Liverpool Street Banners	9
Program 5 – Sandy Bay Road Banners.....	10
Production of Banners and General Information	11
Banner Sizes and Quantities	13
Steps taken to book your Civic Banner Program.....	14
Installation Costs	15
Appendix 1.1 Arterial Half Set Banner – Sleeved	16
Appendix 1.2 Arterial Half Set Banner – Battened	17
Appendix 1.3 Small CBD Banner Elizabeth Mall and Criterion Street	18
Appendix 1.3A Small CBD Banner Elizabeth Street Bus Mall	19
Appendix 1.3B Elizabeth Street Bus Mall (Multipole Data Sheet)	20
Appendix 1.4 Large CBD Banner.....	21
Appendix 1.5 North Hobart Banner.....	22
Appendix 1.6 Liverpool Street Banner.....	23
Appendix 1.7 Liverpool Street Banner (Multipole Data Sheet)	24
Appendix 1.8 Sandy Bay Road Banner	25
Appendix 1.9 Sandy Bay Road Banner (Multipole Data Sheet).....	27
Other Promotional Opportunities.....	28



WELCOME TO THE CITY OF HOBART'S CIVIC BANNER PROGRAM

INTRODUCTION

Displaying banners in the City of Hobart is a highly effective way to publicise an upcoming event, activity or community campaign to a wide audience.

The City of Hobart's civic banner poles are available for hire by organisations to publicise eligible events and activities. The program is divided into a number of locations across the city that can be booked.

The hire fees are calculated at a rate to cover the cost of installation.

This document provides guidelines on how to maximise opportunities within the Civic Banner Program to promote a range of events and activities.

PROGRAM ELIGIBILITY

Banner bookings are accepted for a range of events and activities that promote Hobart. To be eligible, events and activities must be sporting, cultural, recreational, community or tourism related.

Bookings that promote a business only will not be considered.

Events and activities that achieve one or more of the following objectives will be considered:

- held within the Hobart municipal area
- increase visitation to Hobart
- provide direct economic benefits to the City
- national or international event of significant civic value.

To find out if your event or activity is eligible for the Civic Banner Program, contact the City at: cityactivation@hobartcity.com.au

LOCATION OF CIVIC BANNER PROGRAMS



Figure 1: Civic Banner Program

ARTERIAL BANNERS

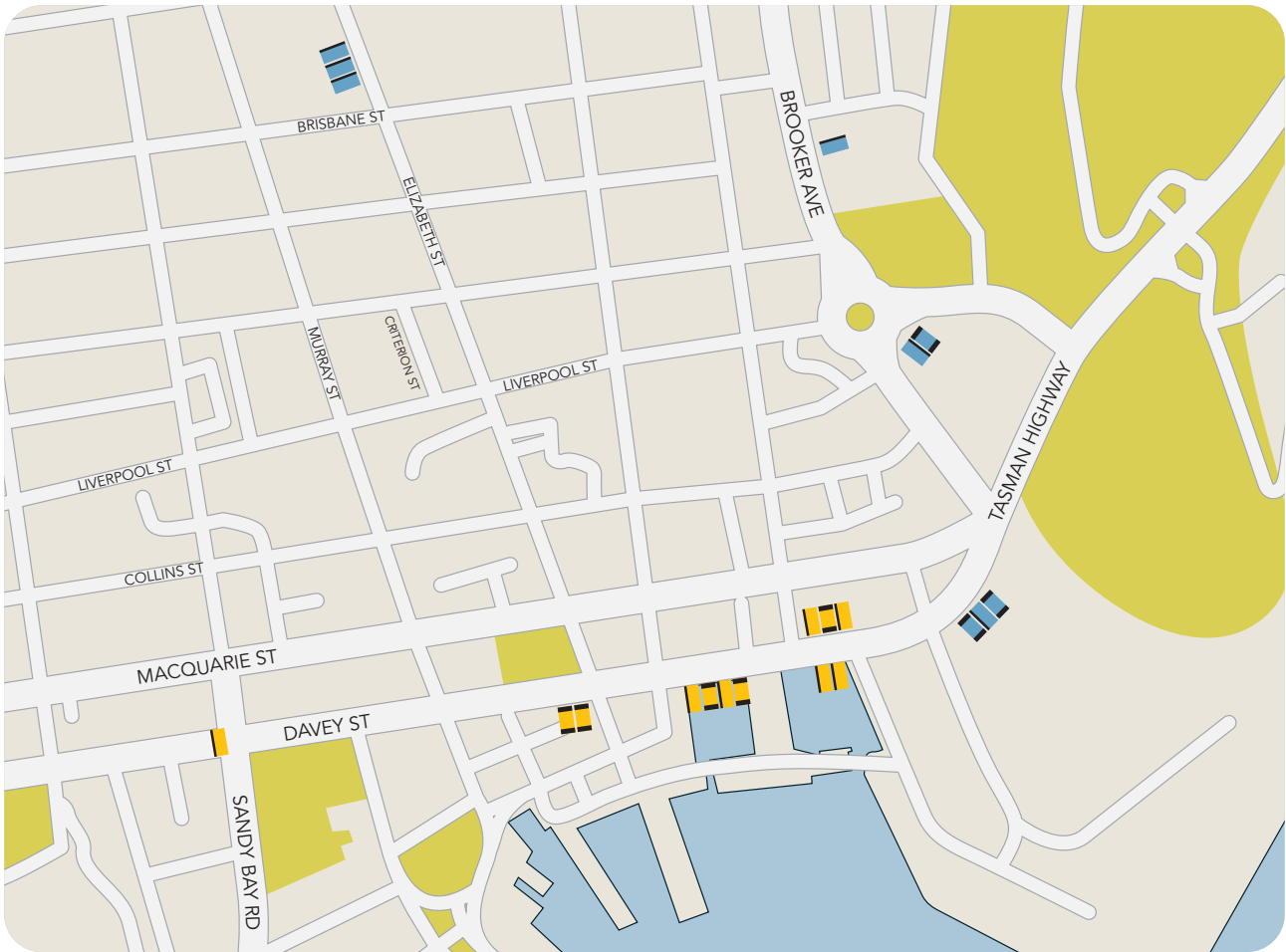





Figure 3. **ARTERIAL HALF SET 1** (Blue on map)  Sleeved banners 900 x 1800 mm NB: Poles for sleeved banners fit TWO banners  Battered banners 900 x 1800 mm NB: Poles for battered banners fit ONE banner only

ARTERIAL HALF SET 2 (Orange on map)  Sleeved banners 900 x 1800 mm NB: Poles for sleeved banners fit TWO banners  Battered banners 900 x 1800 mm NB: Poles for battered banners fit ONE banner only

The Arterial location consists of two Half Sets – set one is Elizabeth St, Railway Roundabout, Gasworks; set two is Davey St between Evans St and Sandy Bay Rd. These streets are the main thoroughfare for vehicular traffic entering and exiting Hobart.

Only one Half Set can be booked for the same event. This program includes both sleeved (refer Appendix 1.1) and battered (refer Appendix 1.2) banners. Banner size is 1800 x 900 mm.

ARTERIAL HALF SET 1 (Blue on map) INCLUDES:

Sleeved banners (2 per pole)	6 banners
Battered banner (1 per pole)	6 banners
Sleeved banners (spare)	1 banner
Battered banners (spare)	1 banner
TOTAL	14 banners

ARTERIAL HALF SET 2 (Orange on map) INCLUDES:

Sleeved banners (2 per pole)	10 banners
Battered banner (1 per pole)	7 banners
Sleeved banners (spare)	1 banner
Battered banners (spare)	1 banner
TOTAL	19 banners

CBD BANNERS

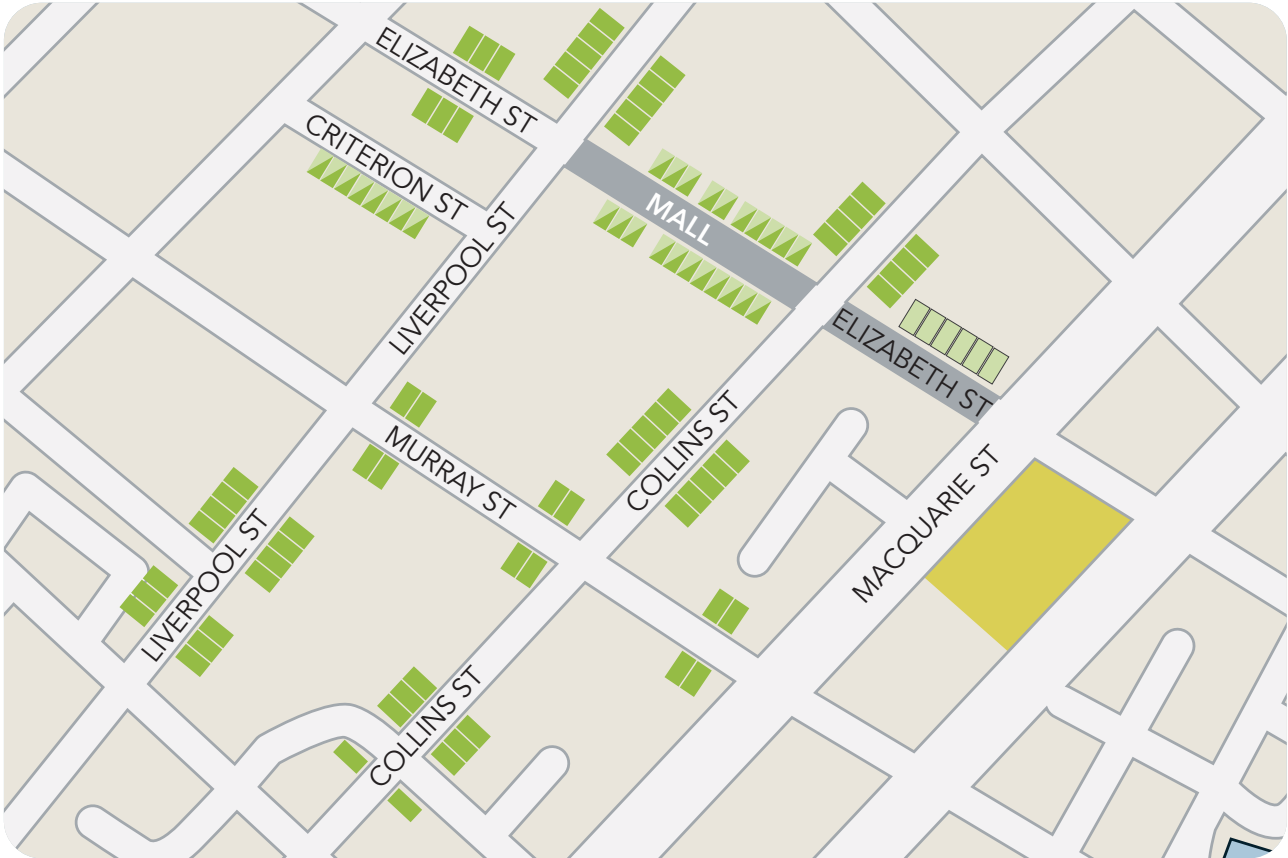
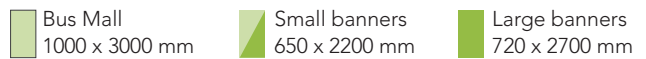

Figure 4: CBD Full Set banner locations.



The CBD Program is made up of Elizabeth Street, Murray Street, Liverpool Street, Collins Street and Criterion Street in the city centre. This area is a popular shopping and eating area with heavy pedestrian traffic.

The CBD banners consist of two areas. There are two different banner sizes:

- Small CBD banners
- Large CBD banners

The Small CBD banners (refer Appendix 1.3, 1.3A and 1.3B) are 650 x 2200 mm and 1000 x 3000 mm and are installed in Elizabeth Mall, Criterion Street and Elizabeth Street bus mall.

The Large CBD banners (refer Appendix 1.4) are 720 x 2700 mm and are installed on the remainder of poles in the CBD area.

The number of banners required will depend on the areas selected (see Figure 5).

Figure 5: CBD banner locations

SMALL CBD

Elizabeth Mall	21
Criterion St	8
Elizabeth St	
Bus Mall	6
Spares	4
TOTAL	39

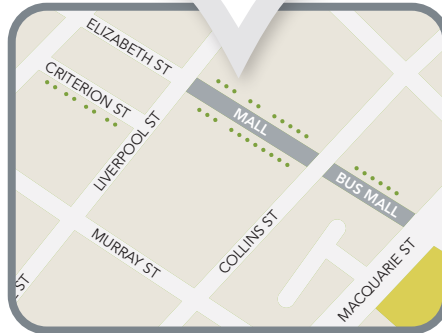

LARGE CBD

Liverpool St	24
Elizabeth St	6
Murray St	12
Collins St	26
Spares	4
TOTAL	72

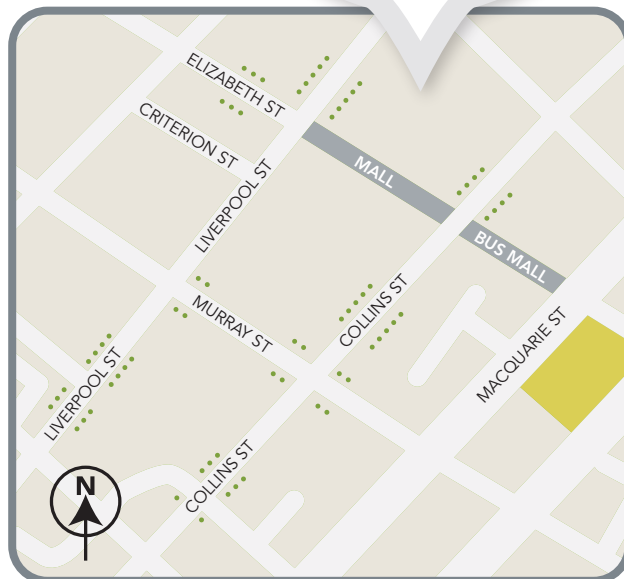

NORTH HOBART BANNERS

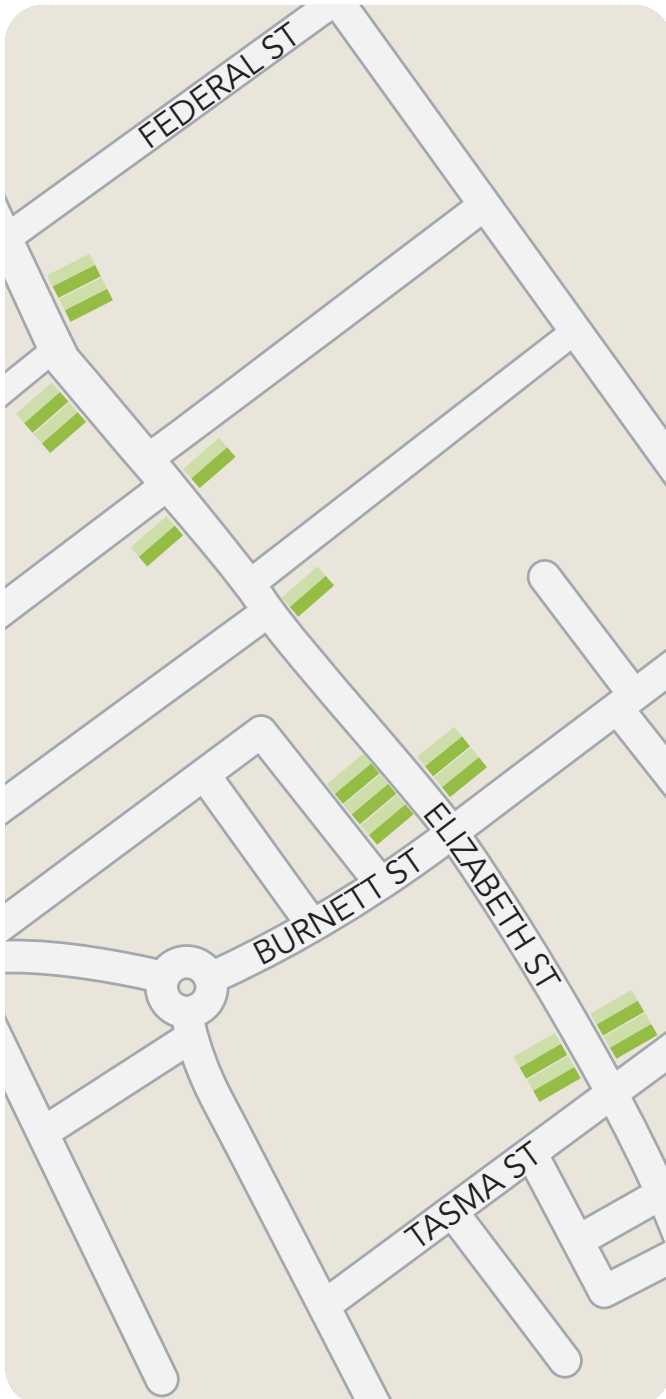

This area of Elizabeth Street is situated in North Hobart and is approximately 2.5 kms from the city centre. It is a popular dining area with heavy pedestrian traffic.

The size of the banners in North Hobart is 650 x 2200 mm (refer Appendix 1.5) and are installed in Elizabeth Street, North Hobart.

NORTH HOBART BANNERS

Full Set: 16 banners

Spares: 4 banners

TOTAL: 20 banners

(Please note: North Hobart banner dimensions are the same as the Small CBD).

Figure 6: North Hobart banner locations.

 North Hobart banners
650 x 2200 mm

LIVERPOOL STREET BANNERS

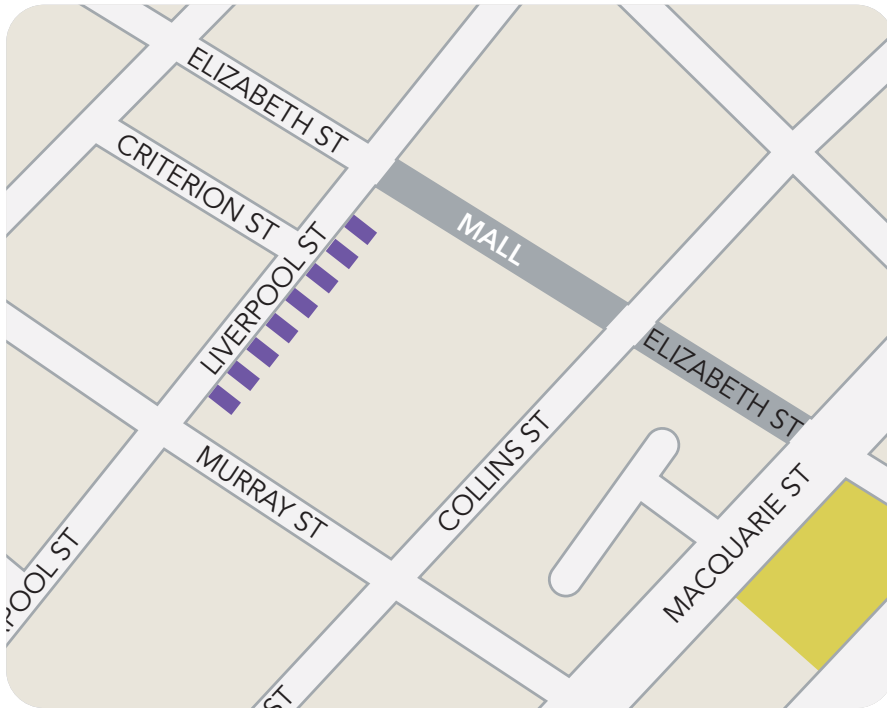

Figure 7: Liverpool Street banner locations.

Liverpool Street banners
800 x 3000 mm

Liverpool Street is situated in the city centre and is home to Myer (Hobart) and other quality retailers and eateries.

The Liverpool Street banner program consists of eight (8) banners between Elizabeth Street and Murray Street.

The dimension of the banners is 800 x 3000 mm (refer to Appendices 1.6 + 1.7)

LIVERPOOL STREET BANNERS

Full Set: 8 banners

Spares: 2 banners

TOTAL: 10 banners

SANDY BAY ROAD BANNERS

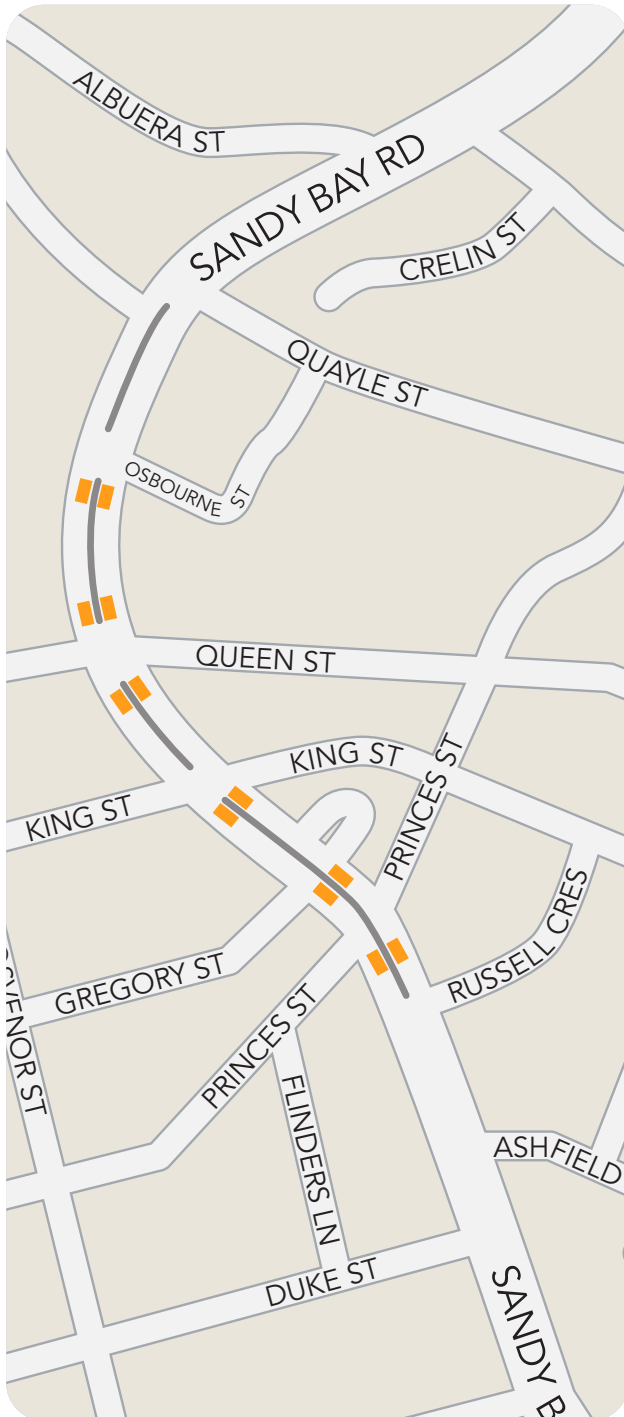



Figure 8: Sandy Bay Road banner locations.

 Sandy Bay Road banners
800 x 3000 mm

Sandy Bay Road is a popular retail precinct and a main arterial road in Hobart.

The Sandy Bay Road banner program consists of twelve (12) banners between Russell Crescent and Osborne Street.

Installation of these banners occurs on Sundays only.

The dimension of the banners is 800 x 3000 mm (refer to Appendix 1.8 and 1.9).

SANDY BAY ROAD BANNERS

Full Set: 12 banners

Spares: 2 banners

TOTAL: 14 banners

PRODUCTION OF BANNERS AND GENERAL INFORMATION

The hirer is responsible for the production and associated costs of the banners. Production must meet the requirements set out in these guidelines. Hirers are responsible for sourcing their own quote directly from the banner manufacturer.

It is recommended that you allow at least 6 weeks for banner production.

Hirers must ensure that battened banners are supplied to the installer with the appropriate sized battens if required. Banner manufacturers should refer to the specifications given for the correct position of the sleeve to be sewn. Hirers should also request that the banner manufacturer include a cost for the appropriate sized battens to ensure banners are not supplied without them. For safety reasons, **ALL** battens must be made of fiberglass. Any banners supplied with battens not made of fiberglass will not be installed.

The City of Hobart will take no responsibility for the manufacture of the banners. The City of Hobart will not install banners that are not manufactured to the banner specifications detailed in these guidelines. If an installation cannot occur due to incorrectly manufactured banners, the hirer may still be invoiced for the cost of installation.

Banners must be delivered to our contractor Hire-Up, at least one week prior to installation.

Please call Hire-Up on 0410 744 706 to organise delivery.

The hirer must also inform the City of the expected delivery date of the banners. This advice can be provided via email to: cityactivation@hobartcity.com.au

BANNER MANUFACTURE

As Hobart can experience frequent strong wind gusts, the manufacturing of all banners **MUST** be able to withstand winds of at least 110 km/h. Banners that do not meet this requirement will not be installed.

The hirer is responsible for ensuring the banner manufacturer has the correct banner specifications, which are at the end of this document.

INSTALLATION AND REMOVAL SCHEDULE

Installations and removals occur on or as close to the scheduled booking date as possible. The confirmed date of installation is subject to weather conditions and availability of installation equipment.

DELIVERY OF BANNERS

Hirers are responsible for the timely delivery and collection of banners. No responsibility will be taken by the City of Hobart regarding storing, maintenance or cleaning of banners.

WHAT HAPPENS TO YOUR BANNERS AFTER TAKE DOWN?

When your banners have been taken down, they can be returned to you or stored with our installer for future use.

Alternatively, if you have no further use for them, the City of Hobart can re-purposed them into items such as shopping and event bags, dust covers for storage areas and other creative items. This is a City of Hobart initiative, contributing to the City of Hobart Waste Management Strategy 2015-2030, working towards zero landfill by 2030. Any logos and other identifying markers on the banners will not be included in the re-purposing process and will be disposed of.

If you would like to discuss this initiative with us, please contact the Activations team on **6238 2486**.

EVENT SUPPORT QUICK RESPONSE GRANT

The City of Hobart offers an In-Kind Venue and Event Resources Quick Response Grant of up to \$1000 for the installation of banners. The grant is designed to assist not-for-profit community organisations and commercial entities that are delivering projects with a community benefit.

PRODUCTION OF BANNERS AND GENERAL INFORMATION (CONT.)

BOOKINGS

Bookings are not available from mid-November until early January each year, due to the installation of festive season and summer event banners.

Tentative bookings will be held for a period of two weeks. After this period, the City of Hobart will endeavour to make contact if no notification has been received from the hirer. The City of Hobart reserves the right to cancel any tentative booking after this period, should attempts at making contact be unsuccessful.

Booking requirements:

- If you wish to book an available banner location, a completed application form is required.
- A Certificate of Currency showing Public Liability is required.
- New banner designs must be approved by the City prior to manufacture.
- For further information regarding the Civic Banner Program and to check availability, please email cityactivation@hobartcity.com.au

BANNER ARTWORK/DESIGN

All artwork/designs must be submitted to the City of Hobart for approval prior to manufacture.

The City of Hobart allows sponsors of an event or activity to be recognised on banners at its discretion. Tobacco, alcohol, gambling, religious and political sponsorship are not permitted on banners.

Any swearing or other language that may be construed as discriminatory or offensive is not permitted on banners.

To maximise the visual effectiveness of a banner, ensuring high readability and effective communication, consider the following suggestions:

- graphics work best as large, bold, colourful and simple icons. Use a minimal amount of text to allow for a larger font size and greater legibility
- sponsor logos should be printed at an adequate size to ensure they can be recognised from a distance

- designs with strong contrast, using dark and bright colours will be more visible
- avoid using dates on banners if they are to be reused in following years.

DAMAGED BANNERS

Spare banners are required to be produced in the case of damage. The number of spare banners for each program is a recommended minimum number only. Banners may be reused for future bookings, provided they are a suitable standard of presentation.

The hirer will be required to pay any additional manufacturing costs to replace damaged banners. If there is an insufficient number of banners, the City of Hobart may arrange for alternative banners to be flown.

The City of Hobart will not compensate a hirer if they are not able to supply the required number of banners. The City of Hobart will not be liable for the cost of replacing or repairing banners.

BANNER SIZES AND QUANTITIES

The Civic Banner Program is composed of eight different banner types.

Banner	Dimensions (mm)	Appendix
Arterial Sleeved	900 x 1800	1.1
Arterial Battened	900 x 1800	1.2
Small CBD	650 x 2200	1.3
Small CBD - Bus Mall	1000 x 3000	1.3A
Large CBD	720 x 2700	1.4
North Hobart	650 x 2200	1.5
Liverpool Street	800 x 3000	1.6 + 1.7
Sandy Bay	800 x 3000	1.8

Table 1: Civic Banners

Figure 2: Banner Types

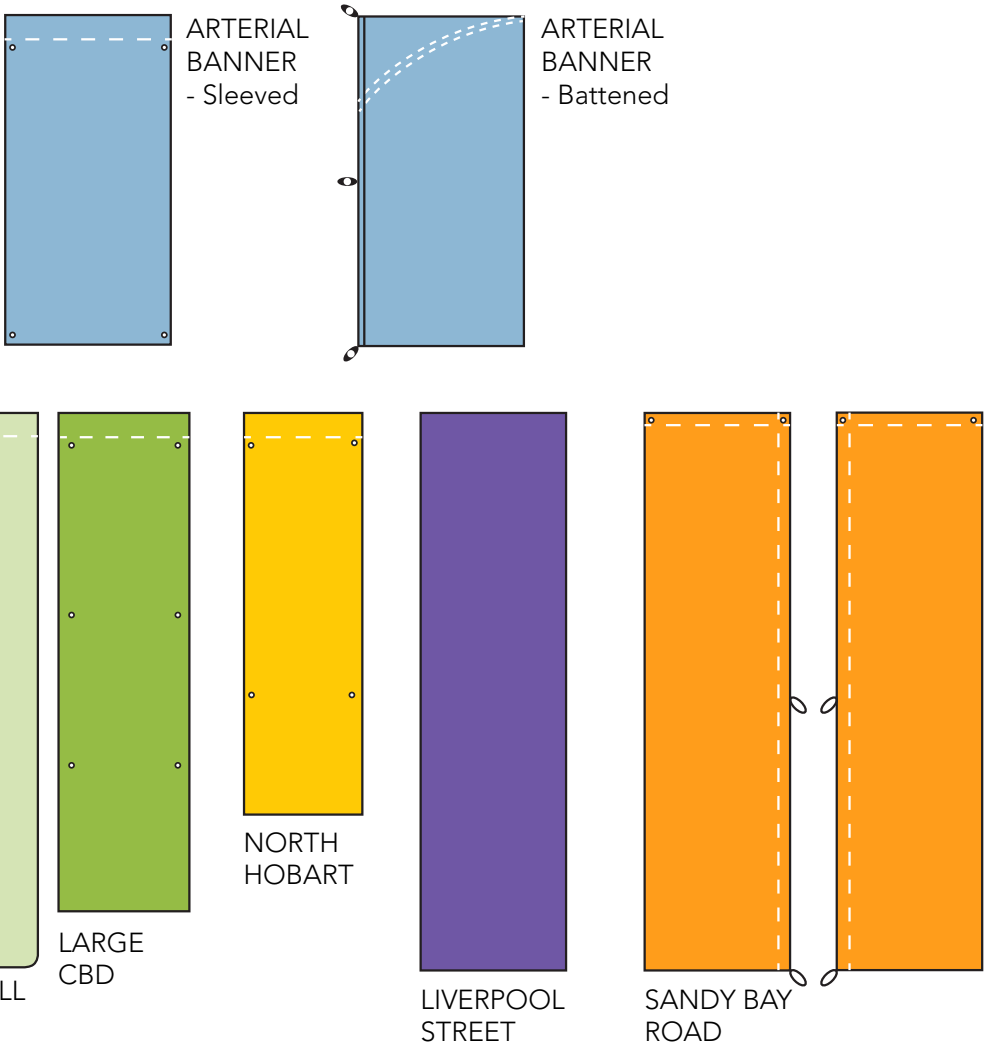

STEPS TAKEN TO BOOK YOUR CIVIC BANNERS

1

CONTACT

City of Hobart to check the availability of the Banner locations.

2

BOOK

- Supply Certificate of Currency.
- Complete and return application form.

3

APPROVAL

The design/s of new banners must be approved by the City prior to manufacture.

4

DELIVERY

- Banners must be delivered at least one week prior to install date.
- Banners installed and hirer invoiced for balance of fees.

INSTALLATION COSTS*

Banner Locations (see Figure 1)	Installed Banners (Excludes spare banners)	Spare Banners (Minimum required)	Installation cost*
Arterial			
Arterial Half Set 1 (900 x 1800 mm)	6 sleeved / 6 battened	1 sleeved, 1 battened	\$1346
Arterial Half Set 2 (900 x 1800 mm)	10 sleeved / 7 battened	1 sleeved, 1 battened	\$1346
Small CBD**			
Elizabeth Mall (650 x 2200 mm) + Bus Mall (1000 x 3000 mm) + Criterion St (650 x 2200 mm)	29 sleeved / 6 sleeved Mall Criterion Bus Mall	3 sleeved / 1 sleeved Mall Criterion Bus Mall	\$1346
Large CBD**			
Full Set	68 sleeved	4 sleeved	\$3074
North Hobart			
Full set (650 x 2200 mm)	16 sleeved	4 sleeved	\$1346
Liverpool Street			
Full Set (800 x 3000 mm)	8 banners	2 banners	\$977
Sandy Bay Road			
Full Set (800 x 3000 mm)	12 banners	2 banners	\$977

Table 2: Civic Banners installation and removal
Costs are effective from 1 July 2024 to 30 June 2025.
* Installation costs are inclusive of GST

PAYMENT OF FEES AND CHARGES

Once the banners have been installed, an invoice for the costs will be sent to the hirer.

CANCELLATIONS

All cancellations must be made in writing to cityactivation@hobartcity.com.au

PAYMENT TERMS

The hirer must, after the provision of a valid tax invoice pay to the Council, on or before the due date showing on the tax invoice. If payment of the fees is not made by this date then daily interest may be charged on the overdue amount at the same rate as the rate that is determined by the Council, from time to time, for the purpose of section 128(2) of the *Local Government Act 1993*.

APPENDIX 1.1

ARTERIAL HALF SET BANNER – SLEEVED

SLEEVED ARTERIAL BANNER 1800 X 900 MM

NB: Poles for Sleeved Banners
fit **TWO** banners.

SPECIFICATIONS

- 4 eyelets
- All eyelets reinforced
- Knitted polyester

ESTMATED PRODUCTION PRICE (GUIDE ONLY)

Arterial
\$1700 to \$2100

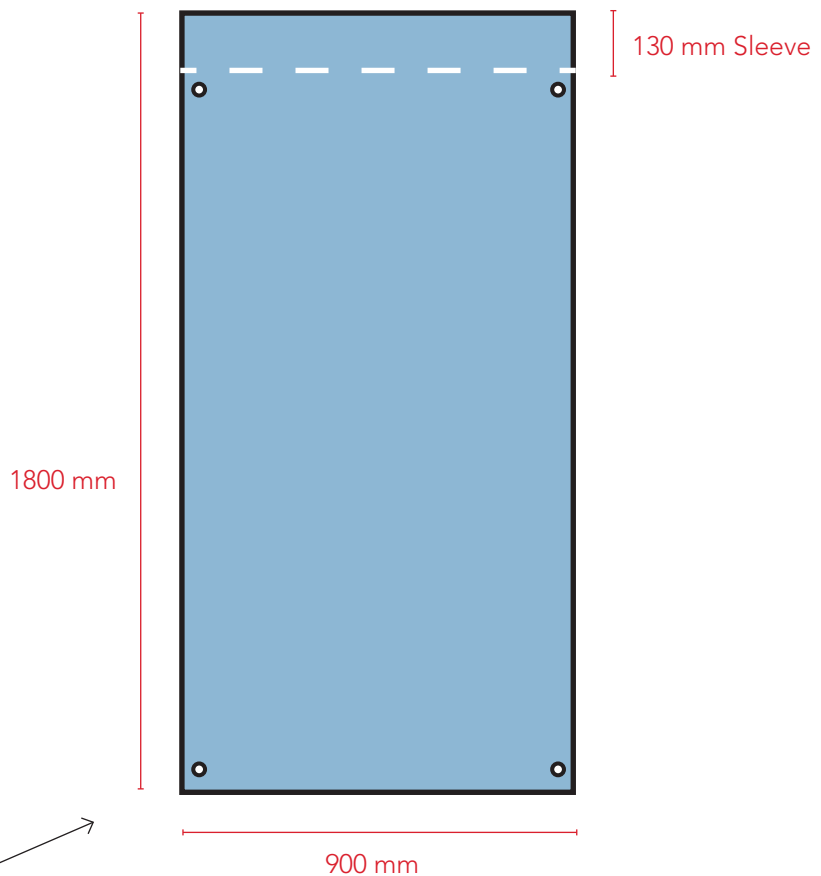

PLEASE NOTE:

Size specifications only.
Contact the banner
manufacturer for
artwork specifications.

APPENDIX 1.2

ARTERIAL HALF SET BANNER – BATTENED

BATTENED ARTERIAL BANNER 1800 X 900 MM

NB: Poles for Battered Banners fit **ONE** banner only.

ARTERIAL BANNER BATTENED

Finished size showing dimensions and fixing points.

Refer to manufacturer for their artwork specifications.

SPECIFICATIONS

- Cable tie attached to pole side of batten (ie drill hole through batten and attach small cable tie to assist with installation)
- Sister clip at top, middle and bottom
- Vinyl binding (left hand side)
- Sleeve along binding on side and top
- Reinforced top outer corner
- Battens must be supplied for these banners. See page 11 Production of Banners.

ESTIMATED PRODUCTION PRICE (GUIDE ONLY)

Arterial
\$1700 to \$2100

PLEASE NOTE:

Size specifications only.
Contact the banner manufacturer for artwork specifications.

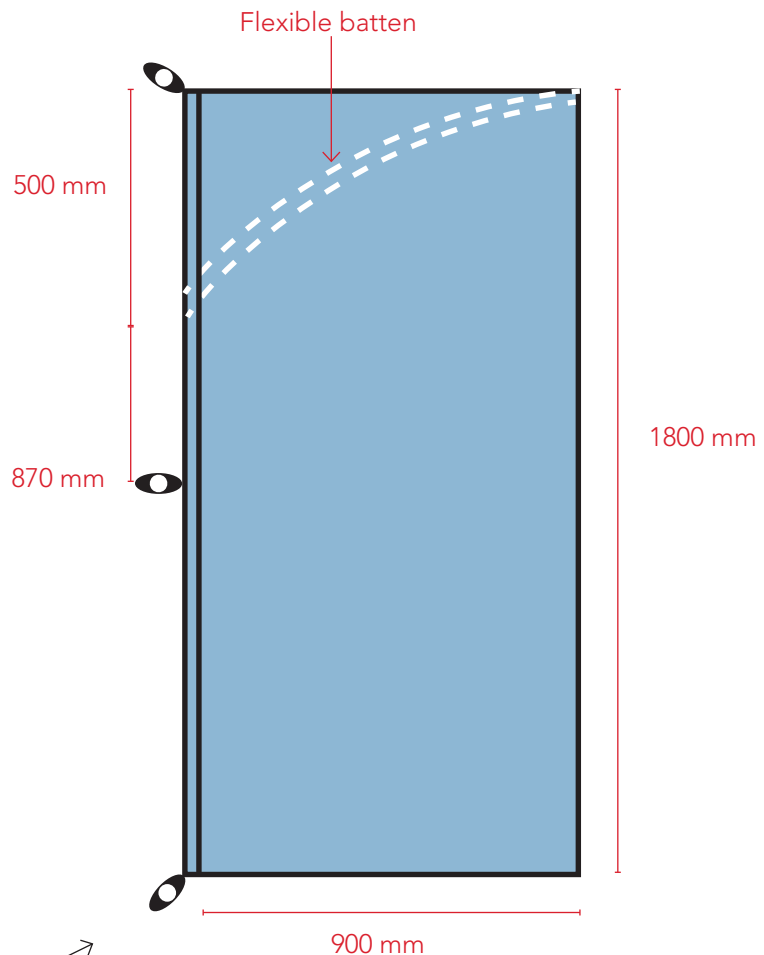

APPENDIX 1.3

SMALL CBD BANNER

ELIZABETH MALL AND CRITERION STREET

SMALL CBD BANNERS 650 X 2200 MM

SMALL CBD

Finished size showing dimensions and fixing points.

Refer to manufacturer for their artwork specifications.

SPECIFICATIONS

- 4 eyelets
- All eyelets reinforced
- Knitted polyester

NB: The 650 x 2200 mm banner is compatible for installation in the Small CBD and North Hobart.

ESTIMATED PRODUCTION PRICE (GUIDE ONLY)

Small CBD (Mall and Criterion St)
\$1300 to \$1700

PLEASE NOTE:

Size specifications only.
Contact the banner manufacturer for artwork specifications.

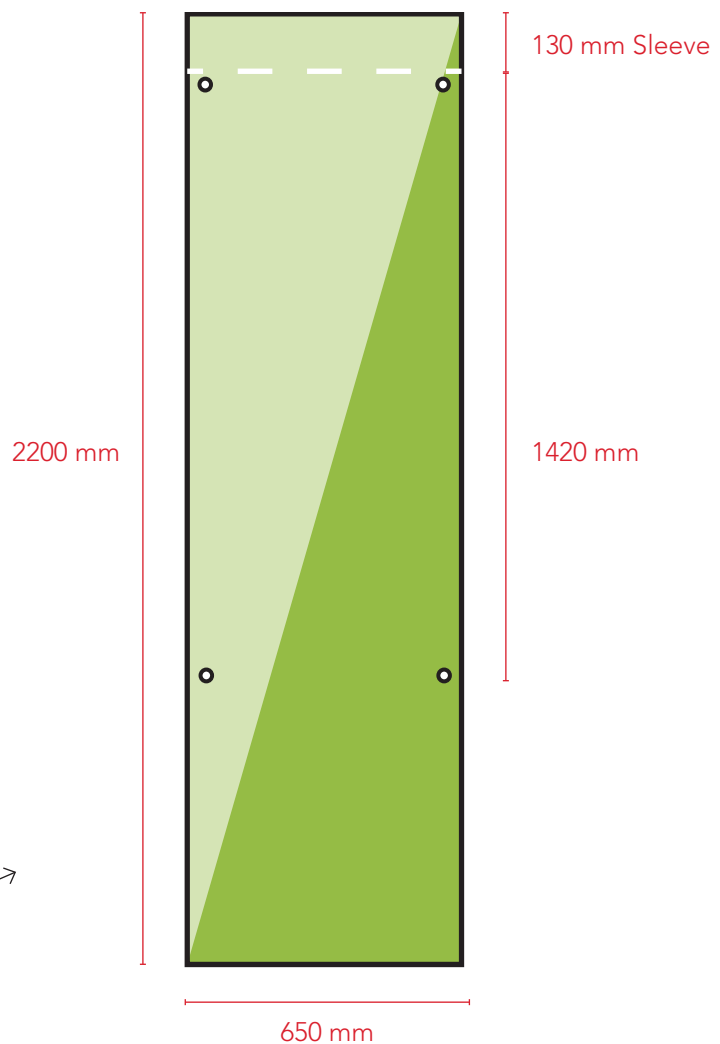

APPENDIX 1.3 A

SMALL CBD BANNER

ELIZABETH STREET BUS MALL

BUS MALL CBD BANNERS
1000 X 3000 MM

BUS MALL CBD

Finished size showing dimensions and fixing points.

Refer to manufacturer for their artwork specifications.

SPECIFICATIONS

- See page 20.

ESTIMATED PRODUCTION PRICE (GUIDE ONLY)

Small CBD (Bus Mall)
\$1300 to \$1700.

PLEASE NOTE:

Size specifications only.
Contact the banner manufacturer for artwork specifications.

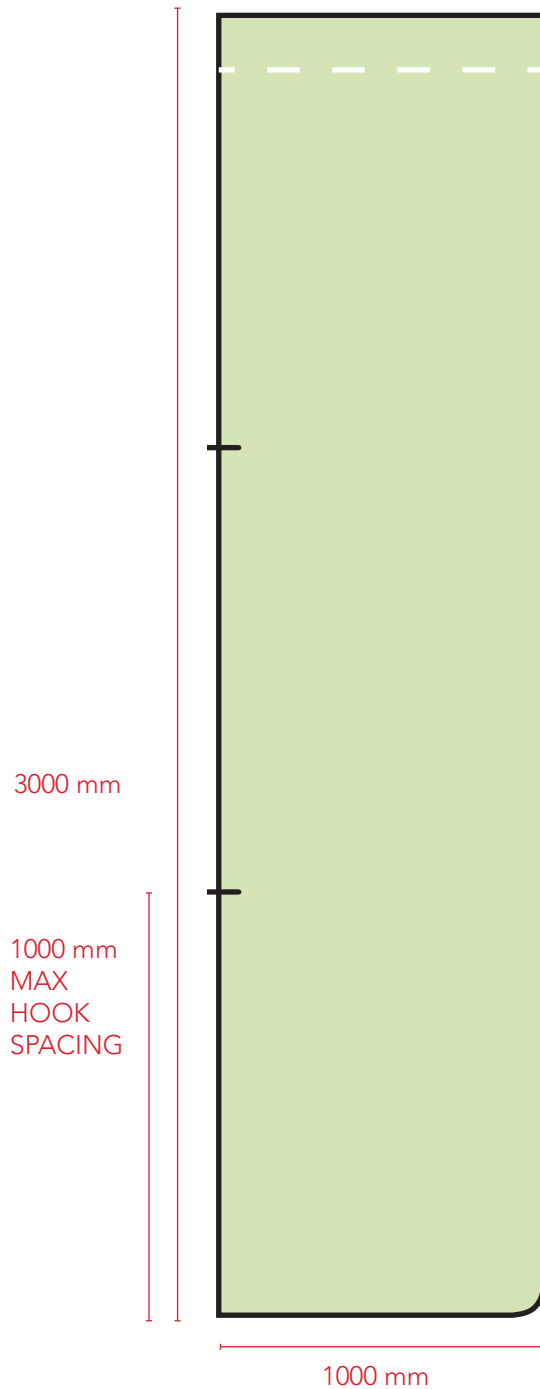

APPENDIX 1.3 B

ELIZABETH STREET BUS MALL

MULTIPOLE DATA SHEET BANNER FINISHING SPECIFICATION

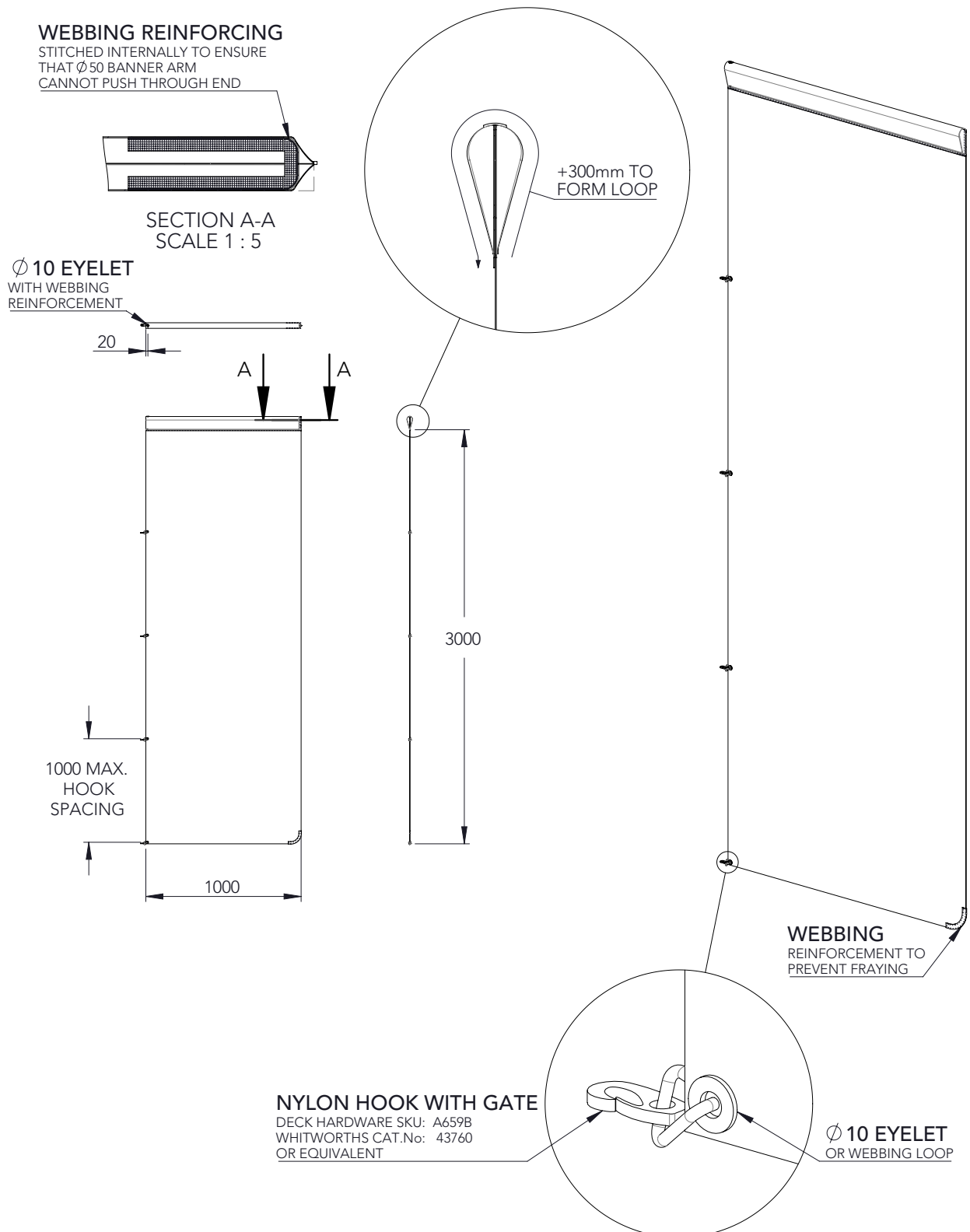

APPENDIX 1.4

LARGE CBD BANNER

LARGE CBD BANNERS 720 X 2700 MM

LARGE CBD

Finished size showing dimensions and fixing points.

Refer to manufacturer for their artwork specifications.

SPECIFICATIONS

- 4 eyelets
- All eyelets reinforced
- Knitted polyester

ESTIMATED PRODUCTION PRICE (GUIDE ONLY)

Large CBD
\$3900 to \$4300

PLEASE NOTE:

Size specifications only.
Contact the banner manufacturer for artwork specifications.

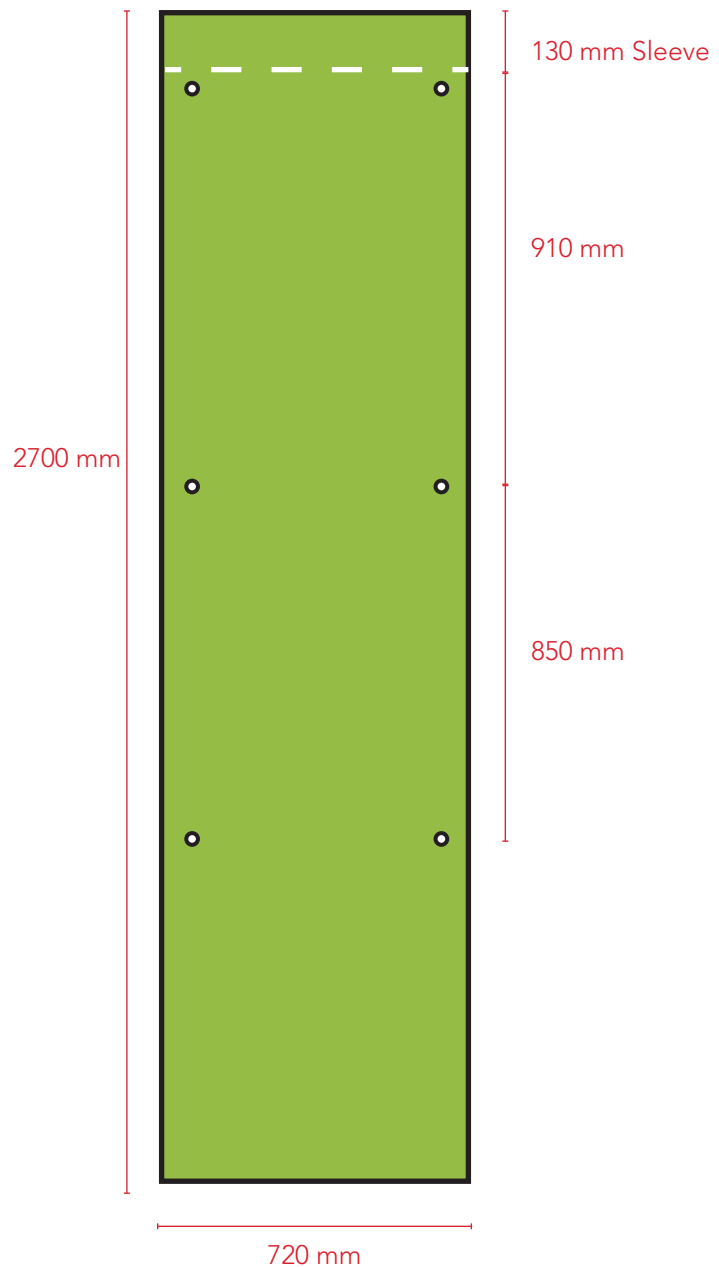

APPENDIX 1.5

NORTH HOBART BANNER

NORTH HOBART BANNERS 650 X 2200 MM

NORTH HOBART

Finished size showing dimensions and fixing points.

Refer to manufacturer for their artwork specifications.

SPECIFICATIONS

- 4 eyelets
- All eyelets reinforced
- Knitted polyester

NB: The 650 x 2200 mm banner is compatible for installation in the Small CBD and North Hobart.

ESTIMATED PRODUCTION PRICE (GUIDE ONLY)

North Hobart
\$1400 to \$1800

PLEASE NOTE:

Size specifications only.
Contact the banner manufacturer for artwork specifications.

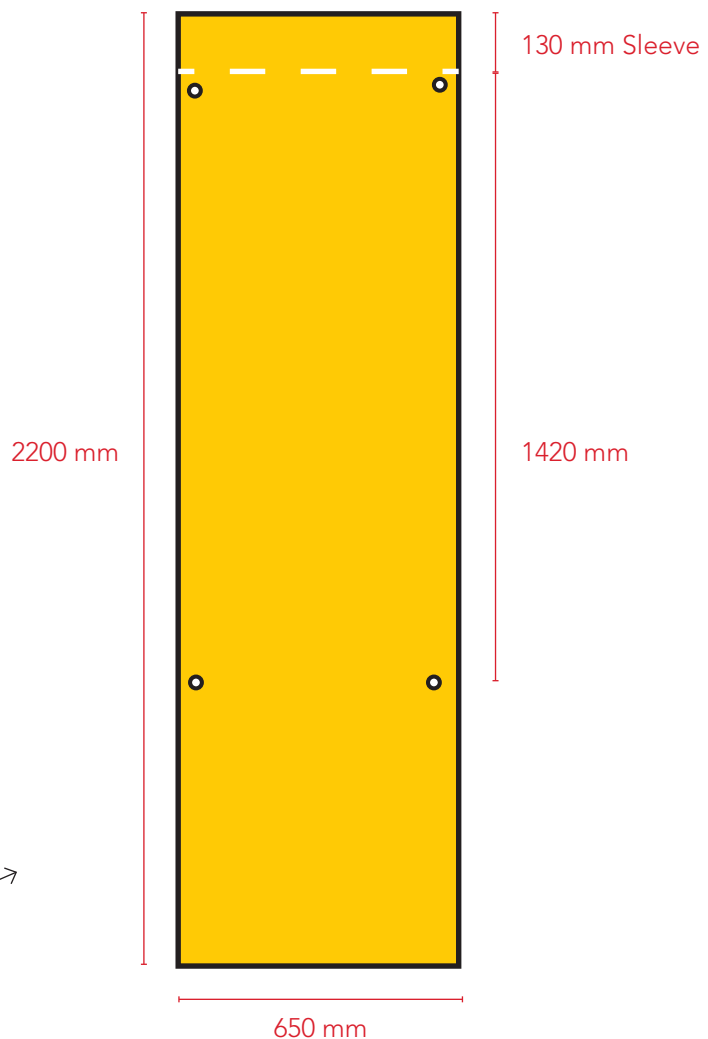

APPENDIX 1.6

LIVERPOOL STREET BANNER

LIVERPOOL STREET BANNERS 800 X 3000 MM

LIVERPOOL STREET

Finished size showing dimensions and fixing points.

Refer to manufacturer for their artwork specifications.

SPECIFICATIONS

- 2 eyelets
- All eyelets reinforced
- 2 webbing loops
- 2 sister clips
- Webbing reinforcement
- Radiused corner

ESTIMATED PRODUCTION PRICE (GUIDE ONLY)

Liverpool Street
\$1200 to \$1600

PLEASE NOTE:

Size specifications only.
Contact the banner
manufacturer for
artwork specifications.

3000 mm

800 mm

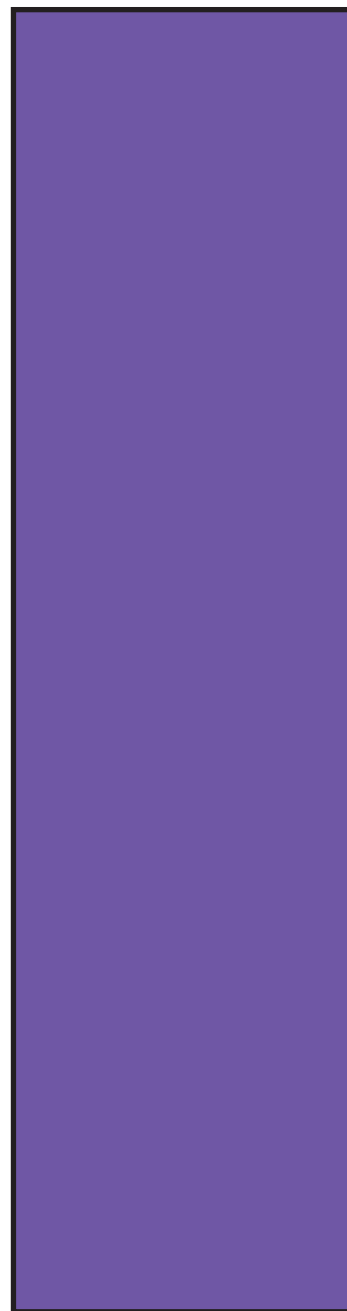

APPENDIX 1.7 LIVERPOOL STREET BANNER

MULTIPOLE DATA SHEET

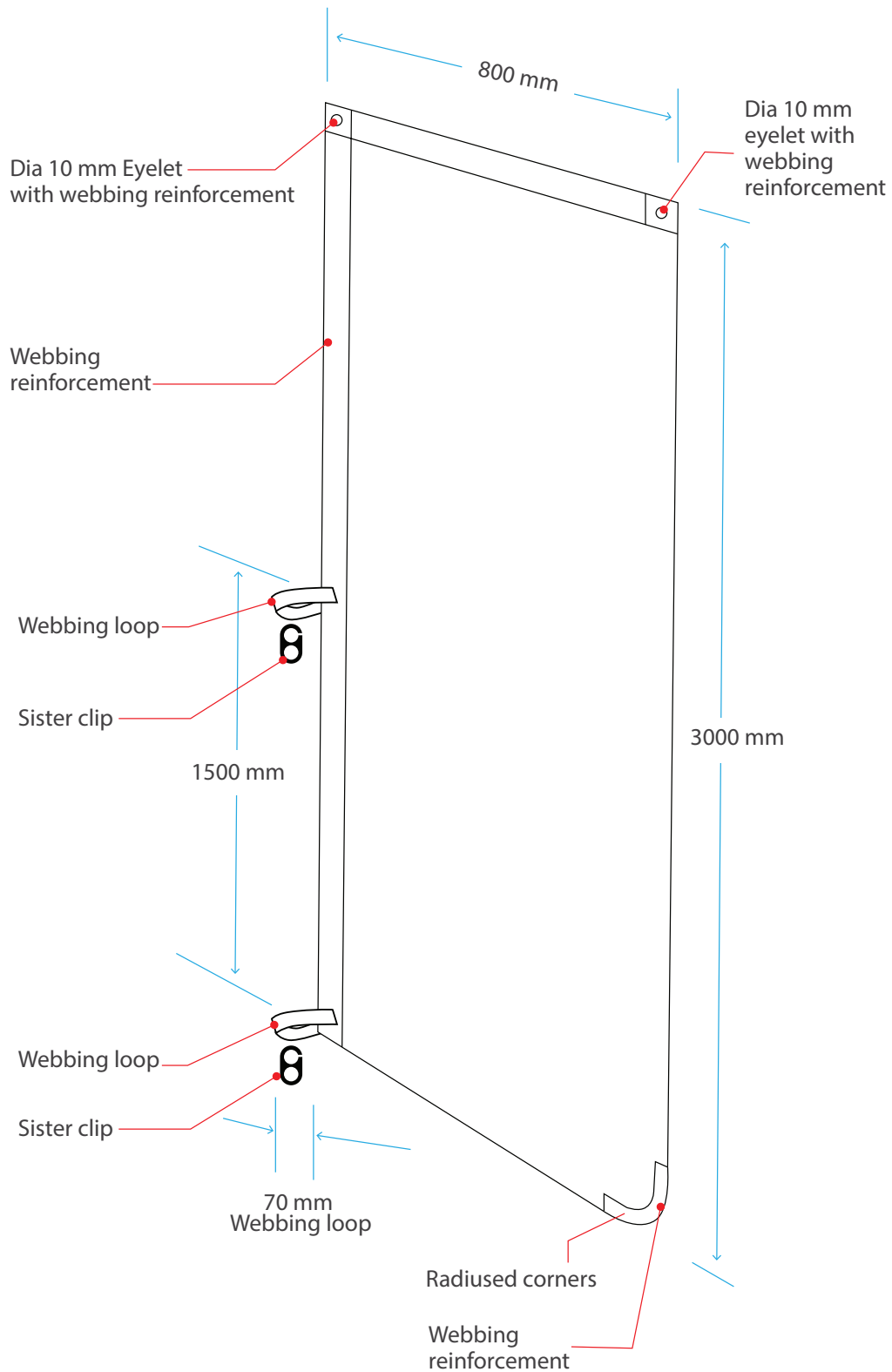

APPENDIX 1.8

SANDY BAY ROAD BANNER

SANDY BAY ROAD
DOUBLE BANNER POLES
800 X 3000 MM

SANDY BAY

Finished size showing dimensions and fixing points.

Refer to manufacturer for their artwork specifications.

SPECIFICATIONS

- 2 eyelets
- All eyelets reinforced
- 2 webbing loops
- 2 sister clips
- Webbing reinforcement
- Radiused corner

ESTIMATED PRODUCTION PRICE (GUIDE ONLY)

Sandy Bay Road
\$1200 to \$1600

PLEASE NOTE:

Size specifications only.
Contact the banner manufacturer for artwork specifications.

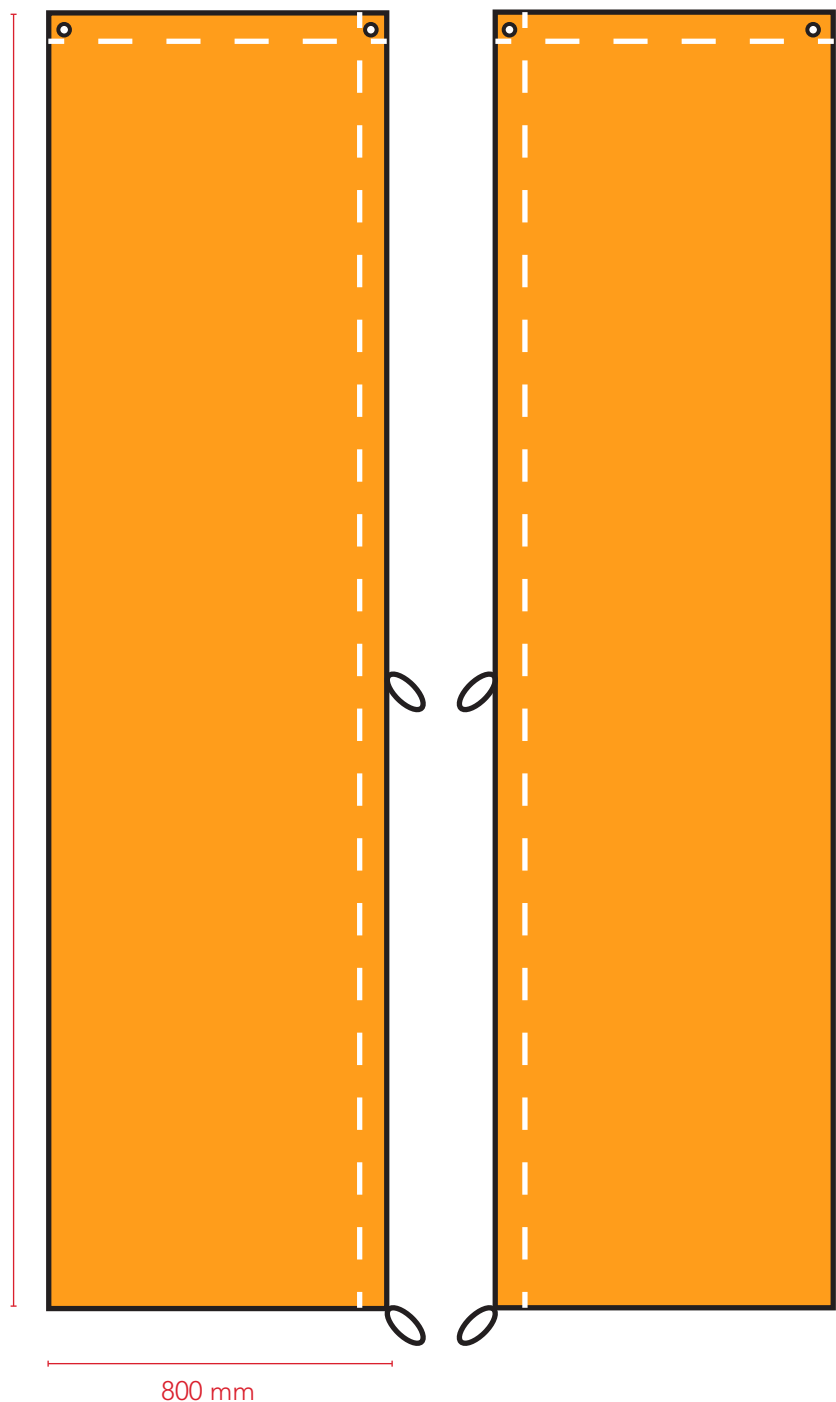

APPENDIX 1.8

SANDY BAY ROAD BANNER CONTINUED

IMPORTANT DESIGN AND PRODUCTION INFORMATION

Banners work as a pair. This means half the banners need webbings on the left and the other half needs them on the right. So the banners can be viewed from both directions, half will be facing citybound traffic and half facing southbound traffic. Banner direction will be alternated every second pole.

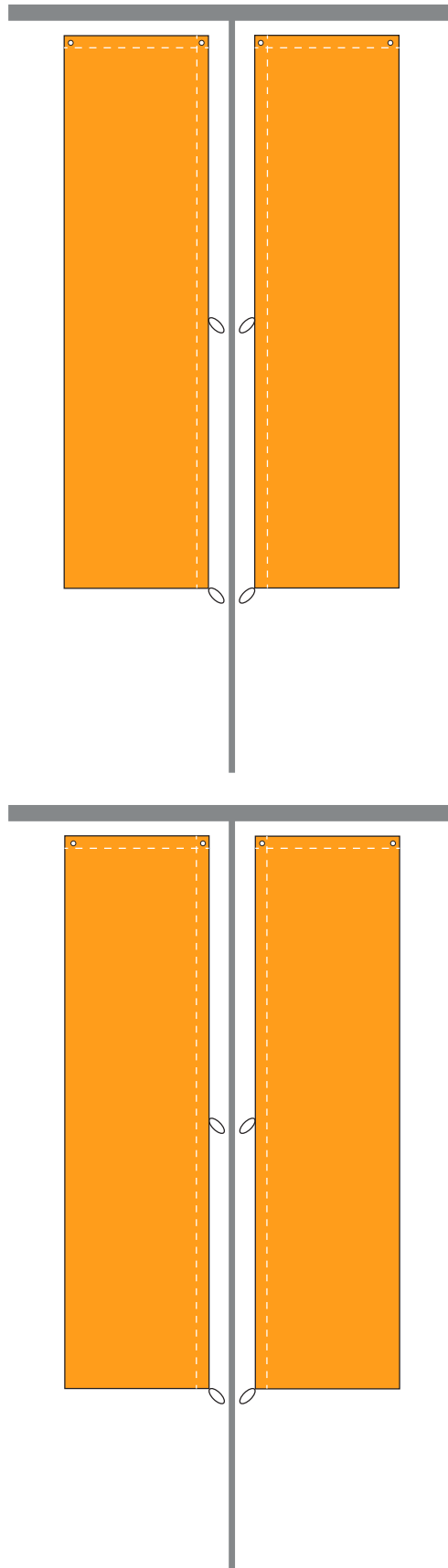

APPENDIX 1.9 SANDY BAY ROAD BANNER

MULTIPOLE DATA SHEET

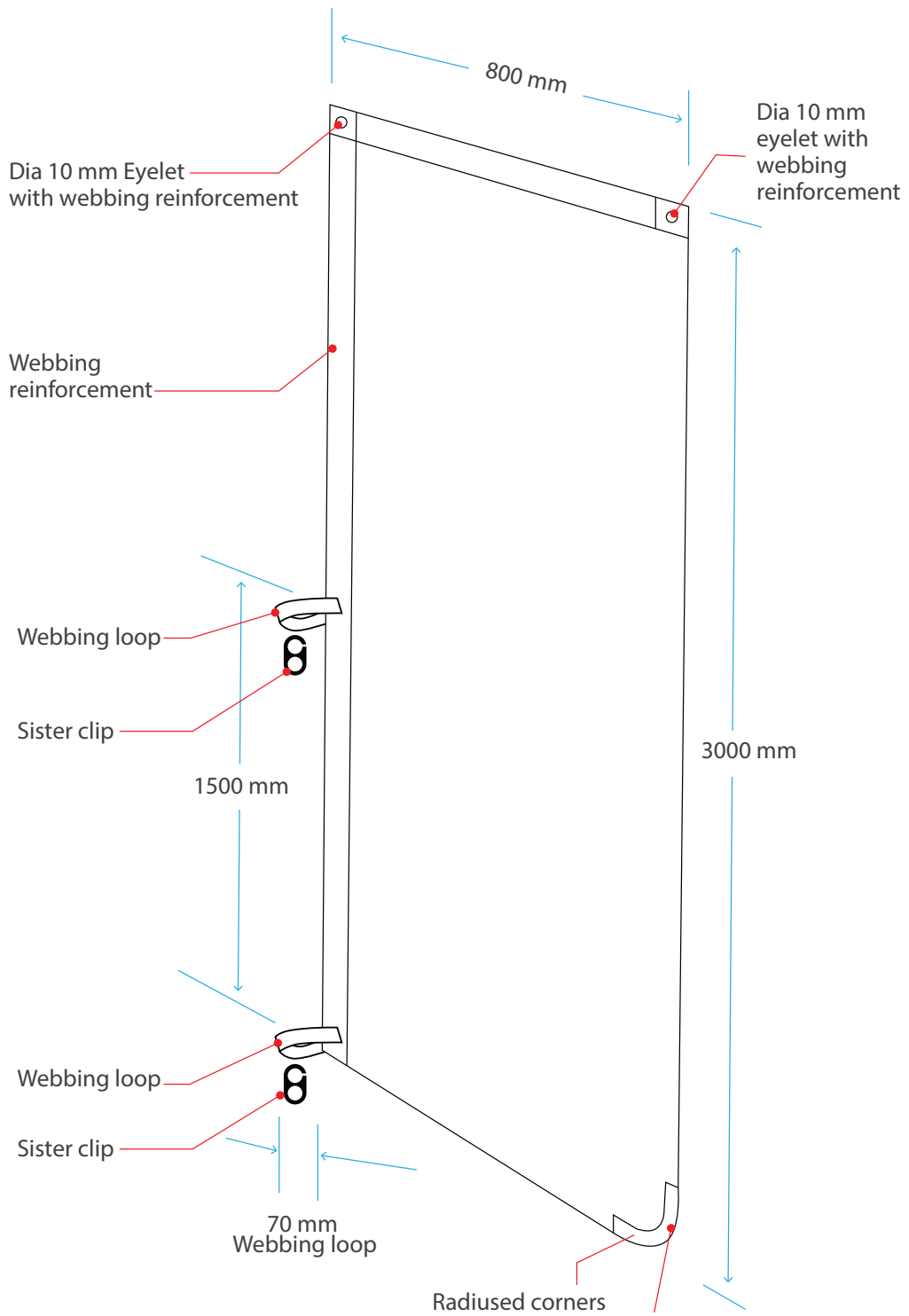

OTHER PROMOTIONAL OPPORTUNITIES

GATEWAY SIGNAGE

Are you organising an event or awareness campaign that you want to promote?

For a fee, you could advertise your event on the Hobart Events signboards on the Tasman Highway (near the Cenotaph) and Brooker Highway (near Risdon Road) for up to four weeks.

More information is available at hobartcity.com.au/City-services/Venues-banners-and-signage/Banners-and-signage

To enquire about availability, please contact us via email at: cityactivation@hobartcity.com.au



EVENT SUPPORT QUICK RESPONSE GRANT

The City of Hobart offers an In-Kind Venue and Event Resource Quick Response Grant of up to \$1000 for the installation of banners. The grant is designed to assist not-for-profit community organisations and commercial entities, which are delivering projects with a community benefit.

To be eligible, your marketing must be for events and activities that are sporting, cultural, recreational, community or tourism-related.

For more information and to apply, please see the In-kind Venue and Event Resources Quick Response Grant Guidelines at hobartcity.com.au/Community/Grants-and-funding/Event-Grants

FESTIVE LIGHTING PROGRAM

The City of Hobart has a range of lighting infrastructure that can illuminate various locations around the city and can be colour coordinated to raise public awareness for events and campaigns.

A variety of colours and colour combinations are possible and, when activated, can increase recognition, support and public pride.

More information is available at

hobartcity.com.au/City-services/Venues-banners-and-signage/Festive-lighting

Hobart Town Hall,
Macquarie Street,
Hobart,
Tasmania 7000 Australia
T 03 6238 2711
F 03 6238 2186
E coh@hobartcity.com.au
W hobartcity.com.au